



MISURA SINGLE MONITOR QHD

THIN & LIGHT HIGH RESOLUTION
PORTABLE 16" MONITOR

USER MANUAL [ENGLISH](#)



Model: P23M16QHD-01



QHD resolution
2560x1440



High Dynamic
Range



Super TFT
display



Ultra Wide
Viewing Angle



Thin stylish
design



Lightweight
materials

No part of this manual, including the products and software described in this manual, may be reproduced, transmitted, transcribed, stored in a data storage system, or translated into any language in any form and by any means, except for documentation stored by the Buyer for backup purposes without the written permission of MISURA Store s. r. o. ("MISURA").

The warranty for the product or service becomes void if: (1) the product is repaired, modified or altered without the written permission of MISURA or (2) the serial number of the product is illegible or missing.

The technical data and information in this manual are provided for information only, are subject to change at any time without notice, and should not be construed as a commitment by MISURA.

MISURA is not responsible for any errors or inaccuracies that may appear in this manual, including the products and software described in this manual.

SAFETY INFORMATION

- Read all supplied documentation carefully before preparing this portable USB-C monitor for use.
- To reduce the risk of fire or electric shock, do not expose this portable USB-C monitor to rain or moisture.
- Do not attempt to disassemble the cover of this portable USB-C monitor.
- Before using this portable USB-C monitor, make sure that all cables are connected properly.
- Avoid extremely dusty environments, changes in temperature and humidity. Do not place the portable USB-C monitor in areas where there is a risk of moisture/splashing.
- Do not allow objects or liquids to enter the holes / cutouts on the cover of the portable USB-C monitor.
- In the event of technical problems with the portable USB-C monitor, contact a qualified service technician or dealer.
- Do not dispose of this product in a fire.
- Do not use this monitor near heating devices or in places subject to high temperatures.
- Keep this monitor away from sharp objects.



1

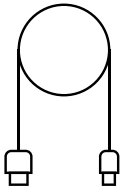

2

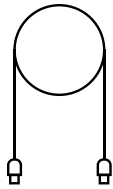

3

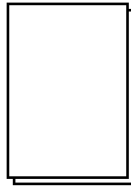

4

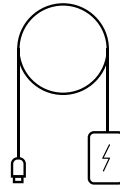

5



6

1. Portable monitor (QHD)
2. HDMI to mini HDMI
3. USB-C to USB-C cable
4. User manual
5. USB-C cable and charger
6. Magnetic case

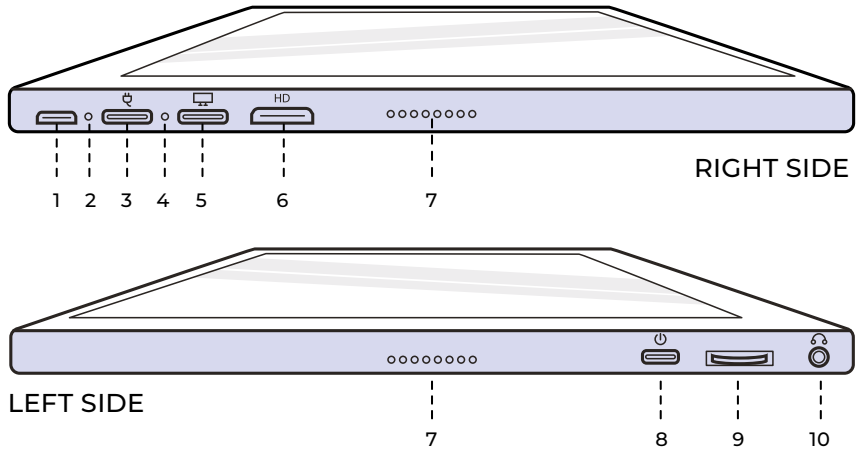

1. Micro-USB Port

Used to connect to keyboard / mouse (may need USB-A to micro USB adapter).

2. Power Indicator Light

3. USB-C Port (Input Power Only)

5V/3A or Quick Charge 18W Input.

4. Input Indicator Light

5. USB-C Port

While connected by HDMI cable do not need Plug in USB A-C cable too. No Input Power through port – make sure to charge via other USB-C port. Output Power: 5V.

6. Mini HDMI Port

Video / Audio input port.

7. Speakers

Audio.

8. Power

Press and hold to turn off and on monitor.

Tap to return while in menu.

9. Wheel Button

Rotate to increase and decrease; the previous and the next. Press to open menu or select option while in menu.

10. Auxillary 3.5 mm

Connect with external audio devices.

USING MONITOR BUTTONS

Power On / Off:

Hold power button for 3 seconds to turn on and off.

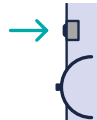

Return / Exit:

Click power button while menu open to return or exit menu.

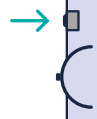

Show Menu / Settings:

Press wheel button.

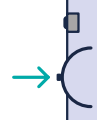

Select Menu Option:

Click wheel button while menu open to confirm / select highlighted option. While on menu status, short press to confirm and save your setting.

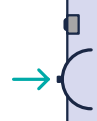

Open Volume Settings:

Toggle wheel button up and press wheel button.

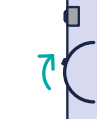

Open Brightness Settings:

Toggle wheel button down and press wheel button.

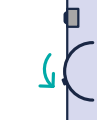

Toggle On-Screen Battery Level:

With valid input signal, toggle wheel button down and press wheel button to show current battery level.

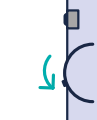

Open Input Source:

Press power button.

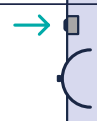

LED INDICATOR LIGHT

Input indicator light

- **Blue Color:** ON / Input source detected.
- **Red Color:** No source / Standby status.
- **Dark:** OFF.

MONITOR MENU SETTINGS

Picture

- **Brightness:** Select brightness level between 0 (lowest) to 100 (highest).
- **Contrast:** Select contrast level between 0 (lowest) to 100 (highest).
- **Volume:** Select loudness levels 0 (lowest) to 100 (highest).
- **Color Gamut:** Select Color Gamut from the following (sRGB, ADOBE, USER, NATIVE)

Color

- **Red:** Select Red level between 0 (lowest) to 100 (highest).
- **Green:** Select Green level between 0 (lowest) to 100 (highest).
- **Blue:** Select Blue level between 0 (lowest) to 100 (highest).
- **Temperature:** 9300k (coolest), 6500k (cool), sRGB (standard Red Green Blue), User (custom).

Advance

- **Saturation:** Select saturation levels 0 to 100.
- **Hue:** Select hue levels 0 to 100.
- **Ultra HDR:** Select On, Auto, Off
- **Language:** Select language.

Other

- **3D Sound:** Select 3D Sound
- **Sharpness:** Select sharpness
- **Mute:** Toggle ON (muted) or OFF (unmuted).
- **EyeProtection:** ON or OFF. Low Blue Light Technology reduces

the emission of the harmful low-blue lights on display in order to prevent eye fatigue.

- **DCR:** Dynamic contrast ratio (ON or OFF). Selecting ON will allow higher contrast ratios.
- **Crosshair:** Toggle ON or OFF
- **Reset:** Reset all settings to factory default.
- **Game Mode:** Toggle ON or OFF
- **Bat Info:** ON or OFF

Input

- Auto Select (recommended)
- Type-C
- HDMI

OSD settings

- **H.Position:** Menu horizontal position. (Set by Wheel button)
- **V.Position:** Menu vertical position. (Set by Wheel button)
- **Transparency:** Menu transparency settings (0 to 100).
- **Menu Time:** How long menu will stay on screen for when turned on (5 to 60 seconds).

Information

Input video source information

Exit

Exit Menu setting

PORTS AND CONNECTION

Video

Connect Monitor to valid source via mini HDMI or USB-C port .

Ensure you do not use the Power Input Only USB-C port .

Please note that not all PC, laptop, or mobile phone USB-C ports output display or video signal. Please see the FAQ for more information.

HOW TO CONNECT YOUR MONITOR

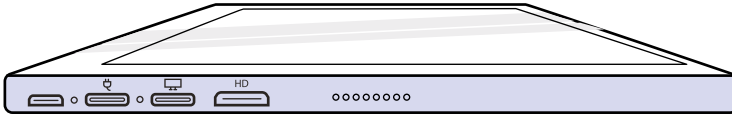

Input

Mini HDMI ← PC / Game Consoles / TV Box / etc.

Input Data Only

USB-C Port ← Input Video / Audio / Touch ScreenPort.

Input Power Only

Power Port ← 18W QC / 5V/3A

Input

Micro USB Port → Keyboard / Mouse (needs Female USB A to Male micro USB adapter).

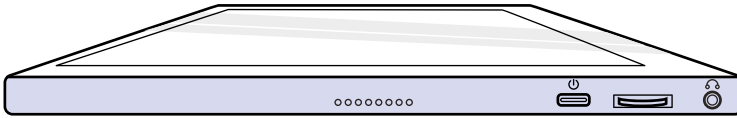

Output

Speakers / Earphones ← AUX 3.5 mm

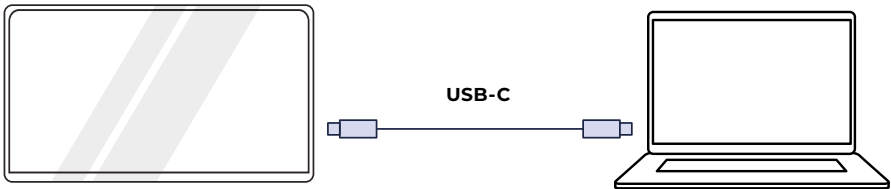

NOTICE: Check if the USB-C of your laptop/phone is full featured USB-C port. Your device should support Thunderbolt 3.0 or USB 3.1 Gen2, USB-C DP ALT-MODE. If it is just USB-C for charging, it will not be available.

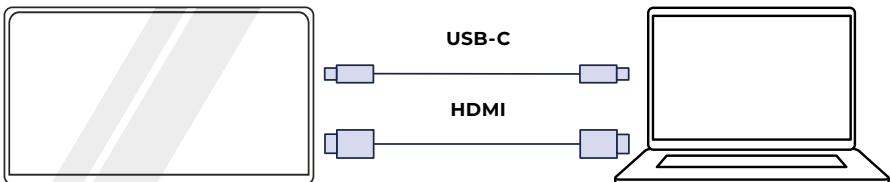

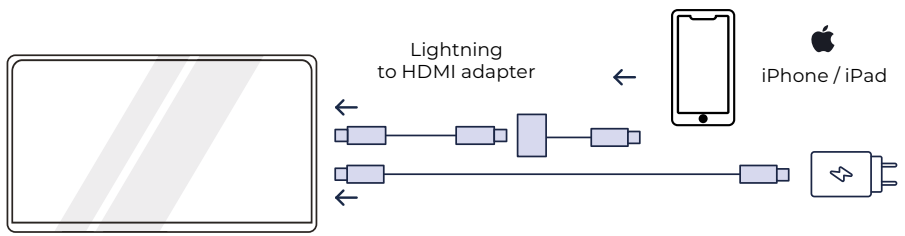
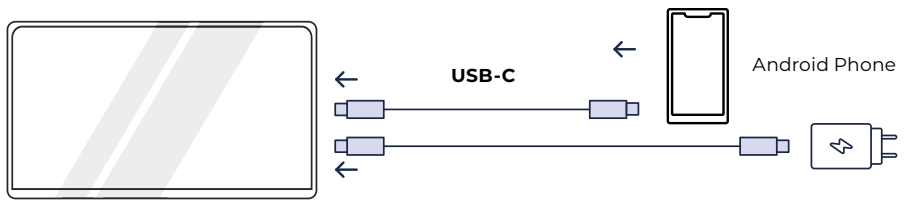
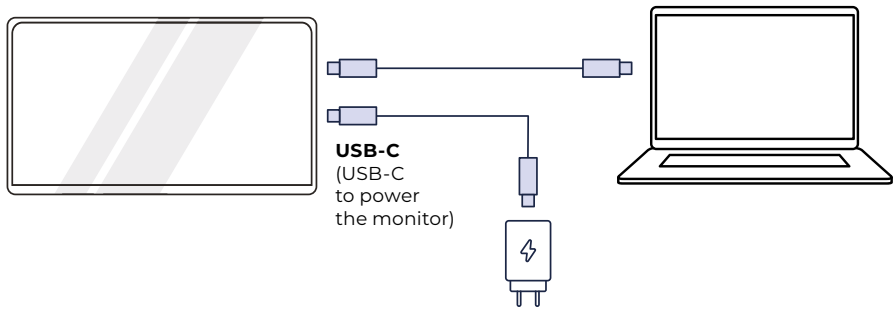
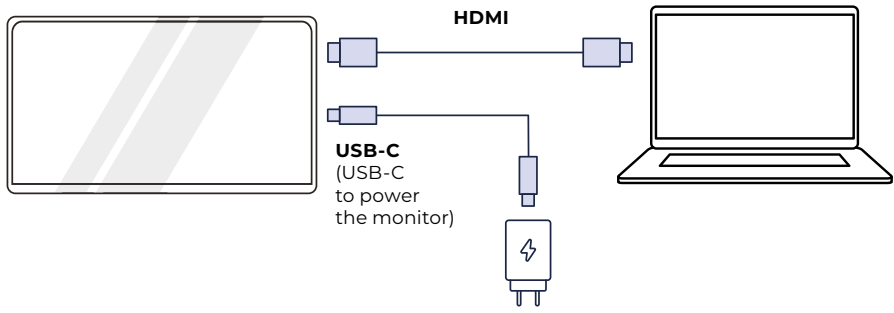

1. My screen does not turn on or I'm seeing a black / blank screen.

It is likely your device is out of battery or you are connecting your external device to the Input Power port rather than the Input Data port.

Monitor uses a very specific battery to optimize for power efficiency, size, and weight. You can ONLY charge your Monitor with a 5V/3A or QC18W charger. Other combinations will not work. We strongly recommend charging and using your Monitor only with our supplied charger.

Please use make sure to charge and connect to your device with our included cables as some generic cables may not carry sufficient power. It is also possible that your external device does not support external displays or requires specific hardware. For example, iPhones and iPads require a specific Lightning to HDMI adapter to connect to external displays. Some mobile devices also do not support external displays from their USB-C ports or at all (e. g. Google Pixel, Windows Surface Pro). This is a limitation by the manufacturer that is unavoidable with many monitors.

Some devices do NOT support USB-C output display signal and you may need to use the HDMI port.

2. Audio is playing from my Monitor screen instead of my laptop or headphones.

Please go into the audio / volume settings on your computer and switch output back to your laptop or headphones.

3. Why isn't my mobile device / tablet connected to the tablet?

- Some phone brands, by design, do not output any display signal. Unfortunately, this means you will not be able to connect the your smartphone to your Monitor. However, you can use devices like the Chromecast, Amazon Fire Stick, or any other media player attachments to connect wirelessly with your monitor.
- For Apple tablets and smartphones, you will need to use a special Lightning-to-HDMI adapter available on our site due to Apple's limitations.
- Make sure your monitor is charged and has power.

5. The speakers aren't working.

Make sure your monitor's volume is not at 0 or muted in the settings.

6. The Power LED Light is on, but there is no screen image.

- Ensure your monitor and input source have power and are on.
- Check that your video input (USB-C or mini HDMI) are properly connected.
- Inspect the signal cable and make sure the pins are not bent or damaged.
- Connect the computer to another monitor to ensure the computer and output port is working properly.
- Your device may not be compatible with external monitors.

7. Screen image is too light or dark.

Adjust brightness settings to increase or decrease brightness.

8. Screen image bounces or a wave pattern is present in the Image.

- Try connecting another input device to your Monitor to ensure the issue is not with your device or accessories.
- Make sure the USB-C cable or HDMI cable is properly connected.
- Move monitor away from other magnetic or electric devices that may cause interference.

9. The device cannot be switched on.

- Try connecting another input device to your Monitor to ensure the issue is not with your device or accessories.
- Inspect the USB-C Cable and make sure that none of the pins are bent.
- Use another USB-C or HDMI cable to connect your device to the Monitor.

10. Screen image has color defects (white does not look white).

- The monitor will shut down when the battery is out of power.
- Make sure the device that powers Monitor has sufficient power.

SPECIFICATIONS

Model number	P23M16QHD-01
Panel Type	IPS
Touch function	Yes
Size	16"
Backlight	WLED
Brightness	400 cd/m ²
Contrast	1200:1
EDP	eDP (2 Lanes), eDP1.2
Pitch	0.13464 × 0.13464 (H×V) [188PPI]
Resolution	2560 × 1600
Aspect	16/10
Response time(typ)	30 ms
View angle	89 (CR≥10)
Surface	Matt
Display color	16.7 Million Colors (8-bit)
LOW BLUE LIGHT MODE / HDR10	Yes / Yes
miniHDMI / Type-C	2560 × 1600@60 Hz
Earphone Jack	Yes
Speaker	Yes (2×1, 0 W)
Power	General (≤13 W)
	Stand by ≤ 0.5 W
Built-in battery	NO
Power range	AC 110-240V 50/60 Hz
Power adapter	5V/3A
Size of monitor	354 × 229 × 9 mm
Weight	0.82kg
Front control	MENU (Brightness +/-, Volume +/-); Power (return)
Windows 7/8/8.1/10/MAC OS	Windows, Mac, Xbox, PlayStation

Declaration of conformity according to the EMC Directive 2014/30 / EC on the harmonization of legal regulations of Member States related to electromagnetic compatibility.

Manufacturer / importer:

MISURA Store s.r.o.
K Pošte 429/2
252 67 Tuchomerice

Person responsible for completing the technical documentation:

Ing. Jirí Mihel – executive director of the company

Description and identification of machinery:

Title: portable USB monitor
Type: P23M16QHD-01

The device described above has been tested in accordance with the above standards and found to comply with the EMC 2014/30/ES. The observations and test results given in this certificate are only relevant for the test sample.

The product complies with the following European Community regulations:

Directive EN 55032: 2015 of the European Parliament and of the Council
- Electromagnetic compatibility of multimedia equipment – Emission requirements.

Directive EN 55035: 2017 of the European Parliament and of the Council
- Electromagnetic compatibility of multimedia devices – Immunity requirements.

HARMONIZED STANDARDS USED:

EN IEC 62368-1:2020, IEC 62321-4:2017, IEC 62321-5:2013, IEC 62321-6:2015, IEC 62321-7-1:2015, IEC 62321-7-2:2017, IEC 62321-8:2017, EN 62368-1





- Open the English manual from here
 - Manuál v Češtině otevřete zde
 - Manuál vo Slovenčine otvoríte tu
- A magyar nyelvű kézikönyvet itt tudja megnyitni
- Das Handbuch in Deutsch können Sie öffnen hier
- Tutaj można otworzyć instrukcję w języku polskim.
- Priručnik na hrvatskom jeziku možete otvoriti ovdje.
 - Odprite priručnik v slovenščini tukaj
 - Aprire il manuale in italiano qui
- Aici puteți deschide manualul în limba română.
 - Aquí puede abrir el manual en español.
 - Aqui pode abrir o manual em português.

Thank you for your purchase.
If necessary, contact us at:

Producer / Importer
MISURA Store s.r.o.,
ID: CZ264 03 714
www.misura.shop
info@misura.shop

